



**RESORTES**

   **NAVE**

**CATÁLOGO  
DE RESORTES 2025**





## Muestrario de resortes

3



## Resortes de compresión

Exteriores de 0.083" a 0.120"

4

### FABRICACIÓN A LA MEDIDA

5

Exteriores de 0.120" a 0.148"

6

### EJEMPLOS DE APLICACIONES

7

Exteriores de 0.148" a 0.175"

8

### FABRICACIÓN EXPRESS

9

Exteriores de 0.175" a 0.193"

10

### KIT DE RESORTES CON MEDIDAS ESTÁNDAR

11

Exteriores de 0.193" a 0.238"

12

### EJEMPLOS DE APLICACIONES

13

Exteriores de 0.238" a 0.250"

14

### RESORTES CÓNICOS Y BICÓNICOS

15

Exteriores de 0.250" a 0.280"

16

### FORMAS DE ALAMBRE REDONDO

17

Exteriores de 0.280" a 0.299"

18

### EJEMPLOS DE APLICACIONES

19

Exteriores de 0.300" a 0.355"

20

### RESORTES DE TORSIÓN

21

Exteriores de 0.356" a 0.363"

22

### PASADORES DE CHAVETAS / CLIPS R

23

Exteriores de 0.364" a 0.375"

24

### RESORTES AL TAMAÑO DE TUS PROYECTOS

25

Exteriores de 0.375" a 0.390"

26

### SOPORTE TÉCNICO DE RESORTES

27

Exteriores de 0.390" a 0.480"

28

### PRECIOS ESPECIALES DE MAYOREO

29

Exteriores de 0.480" a 0.500"

30

### ¿NO ENCONTRASTE TU RESORTE?

31



## Resortes de tensión

Exteriores de 0.120" a 0.189"

32

Exteriores de 0.195" a 0.250"

33

Exteriores de 0.270" a 0.460"

34

Exteriores de 0.476" a 0.506"

35

NÚMERO	TIPO	DIÁMETRO EXTERIOR (In)	CALIBRE DE ALAMBRE (In)	LARGO TOTAL (In)	PRECIO EN PESOS MXN
1	COMPRESIÓN	0.540"	0.040"	2.000"	\$ 16.24
2	COMPRESIÓN	0.660"	0.048"	1.580"	\$ 16.24
3	COMPRESIÓN	0.642"	0.063"	1.520"	\$ 16.24
4	COMPRESIÓN	0.468"	0.035"	1.500"	\$ 16.24
5	COMPRESIÓN	0.528"	0.040"	1.414"	\$ 16.24
6	COMPRESIÓN	0.386"	0.034"	1.245"	\$ 16.24
7	COMPRESIÓN	0.362"	0.050"	1.177"	\$ 16.24
8	COMPRESIÓN	0.414"	0.039"	1.162"	\$ 16.24
9	COMPRESIÓN	0.368"	0.032"	1.050"	\$ 16.24
10	COMPRESIÓN	0.312"	0.026"	1.000"	\$ 16.24
11	COMPRESIÓN	0.360"	0.032"	0.875"	\$ 16.24
12	COMPRESIÓN	0.200"	0.018"	0.370"	\$ 11.60
13	COMPRESIÓN	0.250"	0.020"	0.500"	\$ 11.60
14	COMPRESIÓN	0.240"	0.019"	0.600"	\$ 11.60
15	COMPRESIÓN	0.300"	0.035"	0.500"	\$ 11.60
16	COMPRESIÓN	0.151"	0.019"	0.600"	\$ 11.60
17	COMPRESIÓN	0.311"	0.019"	0.714"	\$ 11.60
18	COMPRESIÓN	0.180"	0.032"	0.686"	\$ 11.60
19	COMPRESIÓN	0.208"	0.018"	0.700"	\$ 11.60
20	COMPRESIÓN	0.189"	0.018"	0.773"	\$ 11.60
21	COMPRESIÓN	0.234"	0.020"	0.750"	\$ 11.60
22	COMPRESIÓN	0.187"	0.013"	1.000"	\$ 11.60
23	COMPRESIÓN	0.190"	0.025"	0.955"	\$ 16.24
24	COMPRESIÓN	0.250"	0.020"	1.000"	\$ 16.24
25	COMPRESIÓN	0.250"	0.043"	1.000"	\$ 16.24
26	COMPRESIÓN	0.244"	0.042"	1.100"	\$ 16.24
27	COMPRESIÓN	0.220"	0.024"	1.500"	\$ 16.24
28	COMPRESIÓN	0.311"	0.025"	2.006"	\$ 16.24

NÚMERO	TIPO	DIÁMETRO EXTERIOR (In)	CALIBRE DE ALAMBRE (In)	LARGO TOTAL (In)	PRECIO EN PESOS MXN
29	TENSIÓN	0.546"	0.035"	6.100"	\$ 23.20
30	TENSIÓN	0.500"	0.044"	5.750"	\$ 23.20
31	TENSIÓN	0.375"	0.045"	5.750"	\$ 23.20
32	TENSIÓN	0.198"	0.024"	4.645"	\$ 23.20
33	TENSIÓN	0.475"	0.038"	4.865"	\$ 23.20
34	TENSIÓN	0.250"	0.035"	3.750"	\$ 23.20
35	TENSIÓN	0.520"	0.062"	4.231"	\$ 23.20
36	TENSIÓN	0.377"	0.044"	3.898"	\$ 23.20
37	TENSIÓN	0.215"	0.023"	2.790"	\$ 18.56
38	TENSIÓN	0.342"	0.028"	2.600"	\$ 18.56
39	TENSIÓN	0.375"	0.031"	2.570"	\$ 18.56
40	TENSIÓN	0.507"	0.062"	2.350"	\$ 18.56
41	TENSIÓN	0.648"	0.062"	1.198"	\$ 18.56
42	TENSIÓN	0.390"	0.035"	2.000"	\$ 18.56
43	TENSIÓN	0.390"	0.030"	1.620"	\$ 18.56
44	TENSIÓN	0.358"	0.040"	1.300"	\$ 18.56
45	TENSIÓN	0.245"	0.030"	0.945"	\$ 18.56



**Material:** Aluminio color natural

**Incluye** números de identificación de los resortes

**Medidas:** 40 x 60 cm

**Mostrario exclusivo para artículos Resortes Nave**

NÚMERO	TIPO	DIÁMETRO EXTERIOR (In)	CALIBRE DE ALAMBRE (In)	LARGO TOTAL (In)	PRECIO EN PESOS MXN
46	CANDADO TIPO R	0.600"	0.091"	1.750"	\$ 20.88
47	CANDADO TIPO R	0.687"	0.125"	2.000"	\$ 23.20
48	CANDADO TIPO R	1.000"	0.125"	2.500"	\$ 30.16
49	CANDADO TIPO R	1.125"	0.125"	3.000"	\$ 34.80
50	CANDADO TIPO R	1.230"	0.187"	3.250"	\$ 41.76
51	CANDADO TIPO R	1.375"	0.187"	4.000"	\$ 55.68

NÚMERO	TIPO	DIÁMETRO EXTERIOR (In)	CALIBRE DE ALAMBRE (In)	LARGO TOTAL (In)	PRECIO EN PESOS MXN
52	TORSIÓN	0.280"	0.032"	0.864"	\$ 20.88
53	TORSIÓN	0.300"	0.032"	1.595"	\$ 20.88
54	TORSIÓN	0.395"	0.043"	1.600"	\$ 20.88
55	TORSIÓN	0.432"	0.042"	2.200"	\$ 20.88
56	TORSIÓN	0.390"	0.050"	1.485"	\$ 27.84
57	TORSIÓN	0.432"	0.040"	2.180"	\$ 27.84
58	TORSIÓN	0.626"	0.063"	3.000"	\$ 27.84
59	TORSIÓN	0.905"	0.075"	1.630"	\$ 34.80
60	TORSIÓN	1.135"	0.110"	3.550"	\$ 39.44

**OBTÉN UN GABINETE ¡GRATIS!**

**Al comprar tu muestrario + 15 piezas de cada modelo.**



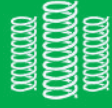

Verifique cantidad de espiras y largo total en sus resortes

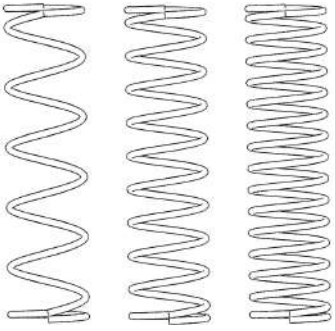

Más espiras = Menor Fuerza  
Menos espiras = Mayor Fuerza

## Referencias

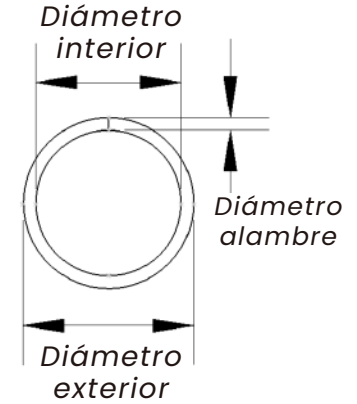
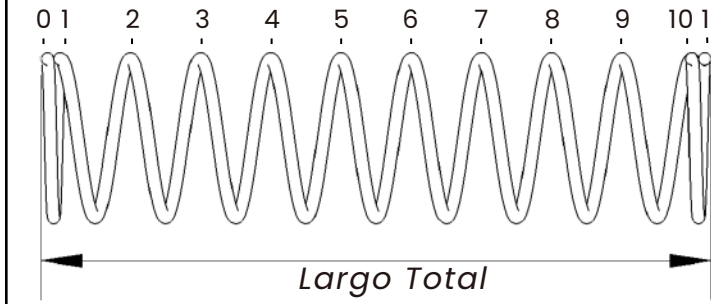

**Materiales:** (MW - Alambre Plano) / (INOX 302/304- Alambre Inoxidable)  
**Acabado:** Natural

↓ Diámetros exteriores desde 0.083" a 0.120" ↓

¿Problemas midiendo tu resorte? **CONTÁCTANOS** y te brindamos **SOPORTE TÉCNICO**

MODELO	DIÁMETRO EXTERIOR (In)	DIÁMETRO INTERIOR (In)	DIÁMETRO ALAMBRE (In)	LARGO TOTAL (In)	ESPIRAS TOTALES	MATERIAL	CARGA (K)	PRECIO EN PESOS (MXN)
N6789	0.083"	0.063"	0.010"	0.500"	11-0/0	MW	4.11 Lb/In	\$ 18.07
N6455	0.086"	0.062"	0.012"	0.270"	08-1/2	MW	11.32 Lb/In	\$ 17.69
N5406	0.098"	0.072"	0.012"	0.885"	26-0/0	MW	1.95 Lb/In	\$ 19.01
N3281	0.100"	0.068"	0.016"	0.325"	09-0/0	MW	22.71 Lb/In	\$ 15.60
N9045	0.100"	0.050"	0.025"	0.920"	24-0/0	MW	60.50 Lb/In	\$ 23.17
N2723	0.106"	0.072"	0.017"	1.160"	27-0/0	MW	6.81 Lb/In	\$ 19.91
N6143	0.108"	0.092"	0.008"	1.500"	31-0/0	INOX	0.18 Lb/In	\$ 29.03
N4030	0.110"	0.064"	0.013"	0.450"	11-0/0	MW	5.00 Lb/In	\$ 16.30
N5389	0.110"	0.082"	0.014"	0.585"	14-0/0	MW	5.20 Lb/In	\$ 17.01
N0941	0.110"	0.094"	0.008"	0.750"	26-0/0	MW	0.23 Lb/In	\$ 19.34
N6142	0.111"	0.081"	0.015"	1.524"	32-0/0	INOX	2.38 Lb/In	\$ 30.58
N9104	0.112"	0.096"	0.008"	0.600"	12-0/0	INOX	0.46 Lb/In	\$ 23.23
N8732	0.113"	0.085"	0.014"	0.331"	08-0/0	MW	9.49 Lb/In	\$ 15.60
N2823	0.115"	0.085"	0.015"	0.719"	15-3/4	INOX	4.60 Lb/In	\$ 25.14
N0289	0.115"	0.085"	0.018"	1.000"	20-0/0	INOX	7.99 Lb/In	\$ 27.32
N9552	0.118"	0.086"	0.016"	0.375"	10-1/4	INOX	9.36 Lb/In	\$ 23.23
N8742	0.118"	0.094"	0.012"	0.500"	12-0/0	INOX	2.18 Lb/In	\$ 23.87
N9272	0.120"	0.100"	0.010"	0.250"	07-0/0	MW	2.16 Lb/In	\$ 15.39
N8873	0.120"	0.096"	0.012"	0.250"	06-1/2	MW	5.26 Lb/In	\$ 15.32
N8047	0.120"	0.080"	0.020"	0.250"	07-0/0	MW	46.00 Lb/In	\$ 15.68
N2261	0.120"	0.096"	0.012"	0.450"	09-0/0	INOX	2.94 Lb/In	\$ 22.84
N5757	0.120"	0.083"	0.018"	0.500"	12-0/0	INOX	12.37 Lb/In	\$ 24.42

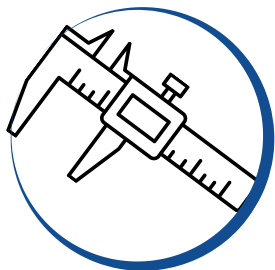

# FABRICACIÓN A LA MEDIDA

Sin importar el **tamaño** de tu proyecto.  
**Lo fabricamos con precisión y calidad** con base  
a tus necesidades.



DESDE RESORTES  
PEQUEÑOS / MILIMÉTRICOS



HASTA LOS RESORTES DE  
MAYOR TAMAÑO



RESORTE  
PROTECTOR  
DE MANGUERAS



RESORTES  
PARA CORTINAS  
METÁLICAS



**¿REQUIERES UN MATERIAL O ACABADO EN ESPECÍFICO?**  
Pregunta por nuestra variedad de alambres y acabados que tenemos para ofrecerte.

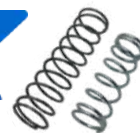

↓ **Diámetros exteriores desde 0.120" a 0.148"** ↓

**Consulta los descuentos en compras POR GRANDES CANTIDADES.**

MODELO	DIÁMETRO EXTERIOR (In)	DIÁMETRO INTERIOR (In)	DIÁMETRO ALAMBRE (In)	LARGO TOTAL (In)	ESPIRAS TOTALES	MATERIAL	CARGA (K)	PRECIO EN PESOS (MXN)
N8947	0.120"	0.098"	0.011"	0.750"	12-0/0	MW	1.63 Lb/In	\$ 16.68
N6507	0.120"	0.092"	0.014"	2.000"	45-0/0	MW	1.08 Lb/In	\$ 25.45
N2851	0.121"	0.075"	0.023"	0.485"	13-0/0	INOX	33.79 Lb/In	\$ 29.65
N8159	0.122"	0.079"	0.020"	0.275"	07-0/0	INOX	37.69 Lb/In	\$ 26.39
N4800	0.122"	0.070"	0.026"	2.500"	51-1/4	INOX	13.11 Lb/In	\$ 49.23
N7422	0.123"	0.086"	0.020"	1.200"	30-0/0	MW	7.52 Lb/In	\$ 22.41
N4904	0.123"	0.097"	0.013"	1.250"	19-0/0	INOX	1.58 Lb/In	\$ 26.77
N5742	0.124"	0.085"	0.018"	0.500"	08-1/2	INOX	16.95 Lb/In	\$ 23.13
N7194	0.124"	0.104"	0.010"	1.000"	16-0/0	MW	0.69 Lb/In	\$ 17.83
N4905	0.124"	0.104"	0.010"	1.250"	21-0/0	INOX	0.44 Lb/In	\$ 27.39
N7716	0.125"	0.093"	0.016"	0.750"	06-1/2	MW	16.17 Lb/In	\$ 15.39
N7030	0.125"	0.075"	0.025"	0.895"	24-0/0	MW	25.52 Lb/In	\$ 21.19
N1922	0.125"	0.075"	0.025"	1.000"	12-0/0	MW	56.15 Lb/In	\$ 17.43
N0285	0.127"	0.107"	0.010"	0.490"	08-0/0	MW	1.50 Lb/In	\$ 15.79
N7983	0.127"	0.095"	0.016"	1.000"	19-0/0	INOX	3.52 Lb/In	\$ 27.04
N9353	0.130"	0.106"	0.012"	1.500"	15-1/2	MW	1.34 Lb/In	\$ 18.05
N0412	0.134"	0.110"	0.012"	0.300"	08-0/0	INOX	2.38 Lb/In	\$ 22.81
N1167	0.135"	0.119"	0.010"	0.288"	05-1/2	MW	2.10 Lb/In	\$ 15.17
N0334	0.135"	0.095"	0.012"	0.300"	03-3/4	MW	9.15 Lb/In	\$ 13.28
N8601	0.140"	0.082"	0.029"	0.350"	09-0/0	MW	106.20 Lb/In	\$ 19.84
N9388	0.140"	0.108"	0.016"	1.500"	18-0/0	MW	3.09 Lb/In	\$ 19.15
N3948	0.141"	0.091"	0.028"	0.712"	12-0/0	MW	61.24 Lb/In	\$ 21.09
N2441	0.142"	0.122"	0.010"	1.000"	28-1/2	INOX	0.21 Lb/In	\$ 31.76
N6332	0.142"	0.110"	0.017"	1.000"	24-1/2	MW	2.73 Lb/In	\$ 21.26
N0507	0.143"	0.110"	0.012"	0.570"	10-1/2	INOX	1.36 Lb/In	\$ 24.37
N9180	0.143"	0.083"	0.030"	1.500"	24-0/0	INOX	31.90 Lb/In	\$ 40.38
N3553	0.145"	0.115"	0.015"	0.575"	11-0/0	MW	3.68 Lb/In	\$ 20.16
N6443	0.145"	0.065"	0.020"	0.750"	12-0/0	MW	11.78 Lb/In	\$ 20.95
N4266	0.145"	0.099"	0.023"	0.930"	20-0/0	INOX	10.70 Lb/In	\$ 35.19
N1623	0.145"	0.121"	0.012"	1.560"	21-0/0	INOX	0.58 Lb/In	\$ 29.00
N7736	0.148"	0.104"	0.022"	0.610"	14-0/0	MW	14.03 Lb/In	\$ 22.20



**Desde lo más sencillo hasta lo más complejo, nuestros resortes son la solución perfecta para tus aplicaciones.**

**Agrícolas**



**Cortinas y rampas**

**Domésticos**



**Equipos hidráulicos**

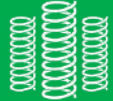

**¿LOS RESORTES DE TU MÁQUINA O EQUIPO REQUIEREN REEMPLAZO?**  
 Visita nuestras sucursales junto con tu muestra, nosotros te lo fabricamos.



↓ **Diámetros exteriores desde 0.148" a 0.175"** ↓

**Precios exclusivos para ventas de CATÁLOGO y compras ONLINE.**

MODELO	DIÁMETRO EXTERIOR (In)	DIÁMETRO INTERIOR (In)	DIÁMETRO ALAMBRE (In)	LARGO TOTAL (In)	ESPIRAS TOTALES	MATERIAL	CARGA (K)	PRECIO EN PESOS (MXN)
N4884	0.148"	0.126"	0.011"	0.725"	11-1/2	INOX	0.75 Lb/In	\$ 24.63
N3171	0.148"	0.105"	0.020"	0.950"	20-1/2	MW	5.93 Lb/In	\$ 20.87
N8646	0.150"	0.090"	0.018"	0.540"	09-0/0	MW	9.37 Lb/In	\$ 19.87
N5621	0.150"	0.090"	0.030"	0.550"	06-0/0	INOX	146.48 Lb/In	\$ 27.78
N2463	0.150"	0.086"	0.032"	0.725"	10-0/0	INOX	99.72 Lb/In	\$ 26.17
N0490	0.150"	0.118"	0.016"	1.000"	18-1/2	INOX	2.06 Lb/In	\$ 28.14
N2439	0.150"	0.086"	0.032"	1.000"	15-0/0	INOX	61.36 Lb/In	\$ 34.51
N5828	0.150"	0.100"	0.025"	1.375"	07-1/2	INOX	45.45 Lb/In	\$ 23.59
N4131	0.154"	0.108"	0.023"	0.500"	10-0/0	INOX	19.45 Lb/In	\$ 29.51
N3828	0.154"	0.110"	0.022"	0.945"	18-0/0	MW	9.15 Lb/In	\$ 20.62
N0316	0.160"	0.100"	0.030"	0.355"	08-0/0	MW	88.33 Lb/In	\$ 17.64
N4660	0.160"	0.100"	0.030"	0.980"	17-0/0	MW	35.33 Lb/In	\$ 25.81
N1289	0.160"	0.080"	0.040"	1.500"	32-0/0	MW	70.99 Lb/In	\$ 34.15
N0180	0.160"	0.134"	0.013"	2.000"	11-3/4	MW	1.33 Lb/In	\$ 17.76
N5689	0.160"	0.120"	0.020"	2.000"	29-0/0	INOX	2.70 Lb/In	\$ 35.26
N6195	0.162"	0.132"	0.015"	0.463"	06-0/0	INOX	4.98 Lb/In	\$ 22.53
N3535	0.162"	0.118"	0.022"	1.500"	22-0/0	INOX	5.34 Lb/In	\$ 37.94
N3320	0.163"	0.139"	0.012"	0.725"	13-0/0	INOX	0.68 Lb/In	\$ 26.10
N2662	0.164"	0.090"	0.037"	1.290"	22-0/0	INOX	57.18 Lb/In	\$ 41.27
N1443	0.168"	0.122"	0.023"	0.725"	10-3/4	INOX	13.11 Lb/In	\$ 26.03
N1928	0.170"	0.144"	0.013"	0.300"	04-1/2	INOX	3.69 Lb/In	\$ 21.88
N9790	0.170"	0.110"	0.026"	0.555"	10-1/2	MW	25.88 Lb/In	\$ 18.15
N2672	0.170"	0.138"	0.011"	1.000"	13-0/0	MW	0.48 Lb/In	\$ 18.34
N2677	0.170"	0.138"	0.011"	1.250"	18-0/0	INOX	0.28 Lb/In	\$ 28.76
N5500	0.170"	0.130"	0.020"	2.000"	25-0/0	MW	2.96 Lb/In	\$ 23.77
N6520	0.170"	0.130"	0.020"	3.543"	46-0/0	MW	1.55 Lb/In	\$ 32.22
N5897	0.170"	0.120"	0.025"	4.250"	55-1/4	MW	3.46 Lb/In	\$ 37.09
N2360	0.175"	0.113"	0.031"	0.370"	05-0/0	MW	148.20 Lb/In	\$ 19.36
N8065	0.175"	0.151"	0.012"	0.420"	12-0/0	INOX	0.60 Lb/In	\$ 26.03
N6654	0.175"	0.095"	0.040"	0.474"	08-1/2	INOX	200.09 Lb/In	\$ 30.72
N4699	0.175"	0.121"	0.027"	0.895"	14-0/0	INOX	17.08 Lb/In	\$ 28.33

# FABRICACIÓN EXPRESS

*Tu solución rápida y eficaz.*

**¿Necesitas tus  
resortes**

**URGENTES?!**

**Nosotros te  
lo resolvemos.**

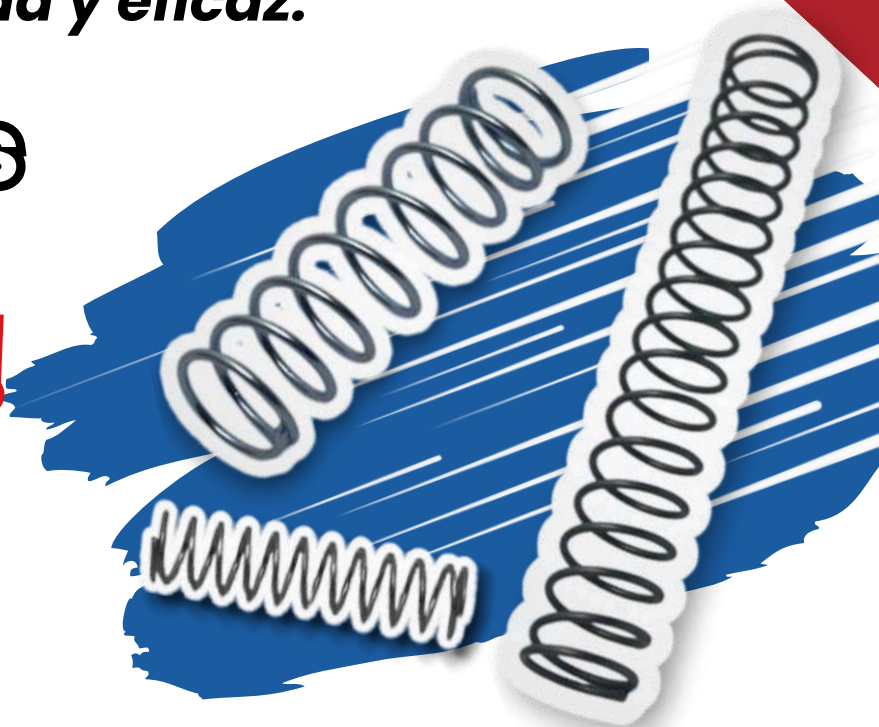

**Contamos con servicios de  
fabricación:**

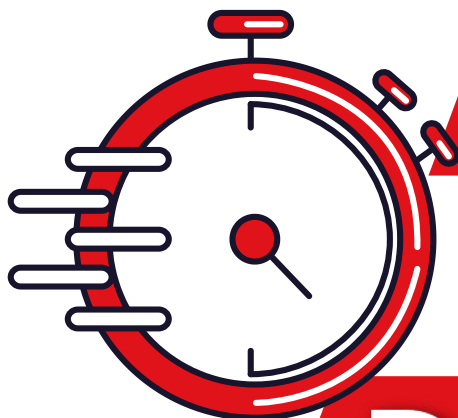

**MISMO DÍA**

**&**

**DÍA SIGUIENTE**

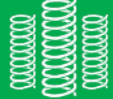

# ¿BUSCAS RESORTES CON FORMA CÓNICA O BICÓNICA?

Consulta a nuestros ingenieros y solicita tu fabricación a la medida.



↓ Diámetros exteriores desde 0.175" a 0.193" ↓

Consulte tolerancias e información adicional al solicitar una ficha técnica.

MODELO	DIÁMETRO EXTERIOR (In)	DIÁMETRO INTERIOR (In)	DIÁMETRO ALAMBRE (In)	LARGO TOTAL (In)	ESPIRAS TOTALES	MATERIAL	CARGA (K)	PRECIO EN PESOS (MXN)
N4699	0.175"	0.121"	0.027"	0.895"	14-0/0	INOX	17.08 Lb/In	\$ 28.33
N0344	0.176"	0.130"	0.020"	0.385"	07-1/2	MW	11.02 Lb/In	\$ 16.79
N2259	0.176"	0.144"	0.016"	0.485"	10-0/0	INOX	2.50 Lb/In	\$ 25.00
N6131	0.176"	0.130"	0.023"	0.745"	11-0/0	INOX	10.85 Lb/In	\$ 26.49
N1738	0.177"	0.143"	0.017"	0.340"	05-1/2	MW	8.37 Lb/In	\$ 15.75
N5656	0.177"	0.139"	0.019"	0.525"	08-0/0	MW	7.92 Lb/In	\$ 20.06
N0135	0.178"	0.130"	0.030"	1.235"	21-0/0	MW	18.90 Lb/In	\$ 29.36
N1575	0.178"	0.148"	0.015"	1.250"	16-0/0	INOX	1.04 Lb/In	\$ 28.39
N5951	0.179"	0.133"	0.018"	0.400"	05-1/2	INOX	8.98 Lb/In	\$ 26.92
N0058	0.179"	0.141"	0.015"	0.750"	13-0/0	MW	1.50 Lb/In	\$ 18.72
N5127	0.179"	0.141"	0.019"	1.000"	16-1/4	INOX	2.79 Lb/In	\$ 34.58
N9521	0.180"	0.144"	0.018"	0.250"	04-0/0	INOX	15.43 Lb/In	\$ 25.86
N7850	0.180"	0.132"	0.024"	0.250"	04-3/4	MW	45.68 Lb/In	\$ 18.65
N5455	0.180"	0.102"	0.039"	0.313"	05-0/0	MW	395.45 Lb/In	\$ 19.44
N6430	0.180"	0.152"	0.014"	0.500"	10-0/0	MW	1.51 Lb/In	\$ 17.59
N8103	0.180"	0.144"	0.018"	0.500"	07-0/0	MW	7.10 Lb/In	\$ 19.63
N1445	0.180"	0.120"	0.032"	0.750"	12-1/2	INOX	38.51 Lb/In	\$ 29.32
N1035	0.180"	0.126"	0.027"	1.000"	17-1/4	INOX	12.16 Lb/In	\$ 36.23
N2352	0.180"	0.108"	0.036"	1.000"	15-0/0	MW	62.20 Lb/In	\$ 21.88
N1576	0.180"	0.126"	0.027"	2.000"	34-3/4	INOX	5.66 Lb/In	\$ 49.23
N6072	0.181"	0.139"	0.021"	2.230"	30-0/0	MW	2.44 Lb/In	\$ 26.56
N6612	0.181"	0.137"	0.022"	6.000"	85-0/0	MW	1.01 Lb/In	\$ 52.01
N0161	0.182"	0.132"	0.025"	1.500"	25-0/0	INOX	5.49 Lb/In	\$ 42.11
N4597	0.183"	0.127"	0.028"	4.000"	69-1/2	MW	3.52 Lb/In	\$ 45.40
N2492	0.185"	0.151"	0.017"	1.470"	36-0/0	MW	0.74 Lb/In	\$ 28.21
N4263	0.185"	0.131"	0.027"	6.000"	86-3/4	INOX	1.99 Lb/In	\$ 76.69
N0469	0.186"	0.162"	0.012"	1.500"	07-3/4	INOX	0.86 Lb/In	\$ 23.99
N8200	0.189"	0.129"	0.030"	4.500"	65-1/4	MW	4.58 Lb/In	\$ 50.40
N1570	0.190"	0.157"	0.026"	0.348"	05-1/2	INOX	37.00 Lb/In	\$ 23.30
N3221	0.190"	0.150"	0.020"	0.450"	07-0/0	MW	9.36 Lb/In	\$ 16.83
N0957	0.193"	0.161"	0.016"	0.250"	04-0/0	MW	8.49 Lb/In	\$ 18.01
N6023	0.193"	0.155"	0.019"	0.774"	11-1/2	INOX	3.26 Lb/In	\$ 31.83



# KIT DE RESORTES CON MEDIDAS ESTÁNDAR

➤ Kit portátil con diversos resortes prácticos para reparadores de maquinaria, equipos ligeros, mecanismos o usos en general.



## Contenido

### Tipos de Resortes

Compresión  
Tensión  
Torsión

### Diámetros Exteriores

Desde 0.187" - 3/16"  
0.250" - 1/4"  
0.375" - 5/16  
Hasta 0.500" - 1/2"

### Largos Totales

Desde 1.750" - 1-3/4"  
2.000" - 2"  
3.750" - 3-3/4"  
Hasta 5.750" - 5-3/4"

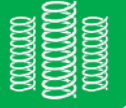

**¡CONTAMOS CON FABRICACIÓN DE CHAVETAS!**  
 Manejamos diferentes diámetros, largos y calibres según tu requerimiento.



↓ Diámetros exteriores desde 0.193" a 0.238" ↓

Las imágenes mostradas en este catalogo son referencias visuales.

MODELO	DIÁMETRO EXTERIOR (In)	DIÁMETRO INTERIOR (In)	DIÁMETRO ALAMBRE (In)	LARGO TOTAL (In)	ESPIRAS TOTALES	MATERIAL	CARGA (K)	PRECIO EN PESOS (MXN)
N1564	0.193"	0.160"	0.012"	1.750"	46-1/4	INOX	0.10 Lb/In	\$ 47.44
N1565	0.193"	0.143"	0.025"	4.126"	41-0/0	MW	3.04 Lb/In	\$ 33.41
N5399	0.194"	0.162"	0.016"	0.500"	08-0/0	MW	2.78 Lb/In	\$ 17.04
N1327	0.195"	0.135"	0.028"	0.760"	13-1/2	MW	16.50 Lb/In	\$ 20.27
N1497	0.195"	0.155"	0.020"	3.000"	18-3/4	MW	2.56 Lb/In	\$ 22.34
N9704	0.195"	0.149"	0.023"	5.500"	64-0/0	MW	1.28 Lb/In	\$ 52.71
N1385	0.198"	0.140"	0.029"	1.775"	09-3/4	INOX	23.63 Lb/In	\$ 26.46
N7075	0.200"	0.144"	0.028"	0.550"	07-0/0	INOX	30.20 Lb/In	\$ 24.57
N1764	0.200"	0.136"	0.032"	0.750"	07-1/2	MW	57.80 Lb/In	\$ 18.34
N9154	0.200"	0.152"	0.024"	0.870"	15-0/0	MW	6.73 Lb/In	\$ 21.19
N4267	0.200"	0.146"	0.027"	1.350"	18-0/0	INOX	8.02 Lb/In	\$ 38.13
N5234	0.220"	0.190"	0.015"	0.500"	07-1/2	INOX	1.34 Lb/In	\$ 28.97
N5246	0.220"	0.160"	0.030"	0.610"	08-0/0	MW	28.29 Lb/In	\$ 22.45
N0593	0.220"	0.174"	0.018"	0.625"	08-0/0	MW	3.05 Lb/In	\$ 17.86
N2855	0.220"	0.172"	0.024"	1.500"	21-0/0	INOX	2.90 Lb/In	\$ 16.24
N3163	0.221"	0.173"	0.024"	0.750"	07-0/0	MW	12.48 Lb/In	\$ 20.66
N2211	0.225"	0.131"	0.047"	1.500"	20-3/4	MW	66.33 Lb/In	\$ 32.57
N9528	0.225"	0.145"	0.040"	2.000"	32-1/4	INOX	16.71 Lb/In	\$ 59.47
N2448	0.227"	0.187"	0.020"	0.400"	08-0/0	MW	4.32 Lb/In	\$ 21.16
N1301	0.229"	0.179"	0.025"	0.475"	08-1/4	INOX	9.20 Lb/In	\$ 30.96
N0326	0.229"	0.167"	0.031"	1.000"	14-0/0	MW	14.25 Lb/In	\$ 27.49
N8990	0.230"	0.202"	0.014"	1.000"	15-1/2	INOX	0.35 Lb/In	\$ 30.65
N5161	0.232"	0.152"	0.040"	1.000"	14-1/2	INOX	36.17 Lb/In	\$ 40.07
N0178	0.232"	0.174"	0.029"	1.265"	21-0/0	MW	6.40 Lb/In	\$ 30.39
N3688	0.233"	0.140"	0.045"	0.500"	04-0/0	MW	443.56 Lb/In	\$ 19.55
N4619	0.234"	0.194"	0.020"	0.750"	08-1/2	INOX	3.14 Lb/In	\$ 11.60
N2638	0.234"	0.170"	0.032"	6.000"	72-1/2	MW	2.59 Lb/In	\$ 64.16
N1641	0.235"	0.195"	0.020"	1.250"	11-1/2	INOX	2.12 Lb/In	\$ 28.68
N4853	0.235"	0.171"	0.032"	2.330"	27-0/0	MW	7.21 Lb/In	\$ 32.69
N1596	0.236"	0.166"	0.035"	0.625"	08-3/4	INOX	34.22 Lb/In	\$ 33.58
N8447	0.238"	0.194"	0.022"	0.850"	10-0/0	INOX	3.63 Lb/In	\$ 33.00



Resortes **versátiles en cualquier aplicación,**  
*disponibles para resolver tus necesidades.*



**Ferretería**



**Grúas de carga**



**Industrial**



**Máquinas tortilladoras**





**¿NECESITAS SABER LA FUERZA Y RECORRIDO DE ALGÚN MODELO?**  
Solicita con nuestros ingenieros una ficha técnica y conoce las especificaciones.



↓ **Diámetros exteriores desde 0.238" a 0.250"** ↓

**¿Tu resorte se rompió? ¡Contáctanos, te lo podemos fabricar!**

MODELO	DIÁMETRO EXTERIOR (In)	DIÁMETRO INTERIOR (In)	DIÁMETRO ALAMBRE (In)	LARGO TOTAL (In)	ESPIRAS TOTALES	MATERIAL	CARGA (K)	PRECIO EN PESOS (MXN)
N3207	0.238"	0.199"	0.018"	1.250"	12-3/4	INOX	1.15 Lb/In	\$ 35.09
N1602	0.240"	0.202"	0.019"	0.285"	04-0/0	INOX	7.55 Lb/In	\$ 22.81
N3598	0.240"	0.199"	0.022"	0.375"	05-0/0	INOX	9.42 Lb/In	\$ 28.06
N6628	0.240"	0.208"	0.016"	0.750"	08-0/0	MW	1.40 Lb/In	\$ 17.83
N2890	0.240"	0.176"	0.032"	0.800"	10-0/0	MW	20.94 Lb/In	\$ 24.67
N0280	0.240"	0.184"	0.028"	0.850"	10-0/0	INOX	10.08 Lb/In	\$ 33.08
N3915	0.240"	0.188"	0.025"	1.000"	12-0/0	INOX	4.91 Lb/In	\$ 35.09
N2272	0.240"	0.156"	0.042"	1.232"	19-0/0	MW	33.90 Lb/In	\$ 32.22
N8935	0.240"	0.200"	0.020"	1.500"	14-0/0	INOX	1.57 Lb/In	\$ 36.38
N7490	0.240"	0.179"	0.032"	2.326"	37-1/2	MW	4.72 Lb/In	\$ 47.69
N5570	0.240"	0.170"	0.035"	6.000"	65-3/4	INOX	3.42 Lb/In	\$ 86.61
N5534	0.241"	0.171"	0.035"	0.500"	04-1/2	INOX	85.83 Lb/In	\$ 28.71
N2699	0.243"	0.207"	0.018"	0.500"	07-0/0	INOX	2.30 Lb/In	\$ 25.31
N4010	0.245"	0.201"	0.022"	0.500"	06-0/0	INOX	6.60 Lb/In	\$ 24.81
N8596	0.245"	0.185"	0.030"	0.600"	06-0/0	MW	29.29 Lb/In	\$ 21.45
N7590	0.245"	0.193"	0.026"	0.826"	10-0/0	INOX	6.80 Lb/In	\$ 33.29
N4882	0.245"	0.183"	0.028"	1.000"	12-1/2	INOX	7.16 Lb/In	\$ 35.88
N0535	0.245"	0.183"	0.031"	1.000"	10-0/0	MW	16.93 Lb/In	\$ 24.85
N3850	0.246"	0.182"	0.032"	0.790"	11-0/0	MW	17.09 Lb/In	\$ 25.74
N6975	0.250"	0.210"	0.020"	0.250"	03-0/0	INOX	16.44 Lb/In	\$ 26.00
N4704	0.250"	0.220"	0.015"	0.375"	05-0/0	INOX	1.63 Lb/In	\$ 23.39
N2521	0.250"	0.164"	0.018"	0.500"	05-1/2	INOX	3.00 Lb/In	\$ 24.20
N7987	0.250"	0.202"	0.024"	0.500"	06-0/0	INOX	8.98 Lb/In	\$ 29.32
N8003	0.250"	0.170"	0.040"	0.500"	07-0/0	MW	79.47 Lb/In	\$ 22.41
N4655	0.250"	0.126"	0.062"	0.500"	05-1/2	INOX	794.21 Lb/In	\$ 35.23
N3641	0.250"	0.180"	0.032"	0.600"	10-0/0	INOX	15.81 Lb/In	\$ 35.76
N3847	0.250"	0.215"	0.020"	0.625"	07-0/0	INOX	3.29 Lb/In	\$ 25.45
N3655	0.250"	0.170"	0.040"	0.625"	09-0/0	INOX	49.36 Lb/In	\$ 34.51
N7329	0.250"	0.210"	0.020"	0.750"	08-0/0	MW	3.15 Lb/In	\$ 18.44
N3031	0.250"	0.200"	0.025"	0.750"	10-3/4	INOX	4.90 Lb/In	\$ 29.14
N6850	0.250"	0.180"	0.035"	0.750"	09-0/0	MW	31.01 Lb/In	\$ 24.16

# RESORTES CÓNICOS Y BICÓNICOS

¡Cotiza la **fabricación** de tus resortes con nuestro equipo, **estamos dispuestos a ayudarte!**



Los diámetros cónicos otorgan al diseño del resorte una mayor fuerza o pueden aportar mayor recorrido total.



COMPRESIÓN CÓNICOS



TENSIÓN CÓNICOS



¡Contáctanos!

Solicita tu cotización y recibe atención personalizada.

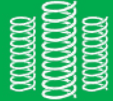

**¿NECESITAS INVENTARIO DE RESORTES CON VARIEDAD DE MEDIDAS?**  
**Adquiere tu KIT PARA TÉCNICO REPARADOR con resortes de medidas estándar.**



↓ **Diámetros exteriores desde 0.250" a 0.280"** ↓

**¿Problemas midiendo tu resorte? CONTÁCTANOS y te brindamos SOPORTE TÉCNICO**

MODELO	DIÁMETRO EXTERIOR (In)	DIÁMETRO INTERIOR (In)	DIÁMETRO ALAMBRE (In)	LARGO TOTAL (In)	ESPIRAS TOTALES	MATERIAL	CARGA (K)	PRECIO EN PESOS (MXN)
N3986	0.250"	0.170"	0.040"	0.900"	11-1/2	INOX	36.37 Lb/In	\$ 37.63
N6793	0.250"	0.194"	0.028"	0.950"	10-0/0	INOX	8.78 Lb/In	\$ 28.49
N4212	0.250"	0.210"	0.022"	1.000"	13-0/0	INOX	2.25 Lb/In	\$ 36.66
N2216	0.250"	0.196"	0.026"	1.000"	17-0/0	INOX	3.39 Lb/In	\$ 40.84
N4766	0.250"	0.210"	0.020"	1.200"	10-0/0	MW	2.36 Lb/In	\$ 23.06
N2922	0.250"	0.200"	0.025"	1.250"	13-0/0	INOX	3.90 Lb/In	\$ 31.15
N0573	0.250"	0.184"	0.033"	1.346"	13-1/2	MW	14.51 Lb/In	\$ 28.06
N3750	0.250"	0.192"	0.025"	1.500"	12-0/0	INOX	4.29 Lb/In	\$ 35.62
N5184	0.250"	0.180"	0.032"	1.500"	13-0/0	MW	13.23 Lb/In	\$ 27.63
N9470	0.250"	0.216"	0.017"	2.000"	15-0/0	MW	0.73 Lb/In	\$ 21.83
N6216	0.250"	0.190"	0.025"	2.000"	16-0/0	INOX	3.06 Lb/In	\$ 39.78
N0395	0.250"	0.184"	0.033"	2.000"	16-0/0	MW	11.92 Lb/In	\$ 30.25
N2370	0.250"	0.200"	0.025"	2.500"	24-1/2	INOX	1.91 Lb/In	\$ 48.69
N0423	0.250"	0.190"	0.030"	3.000"	35-0/0	MW	3.31 Lb/In	\$ 46.83
N3843	0.250"	0.170"	0.040"	3.000"	23-0/0	MW	18.92 Lb/In	\$ 36.38
N4863	0.250"	0.190"	0.030"	6.000"	84-0/0	INOX	1.16 Lb/In	\$ 108.73
N1724	0.250"	0.175"	0.040"	6.000"	72-0/0	INOX	4.94 Lb/In	\$ 112.96
N2257	0.251"	0.197"	0.026"	0.355"	05-0/0	INOX	16.72 Lb/In	\$ 24.06
N3267	0.251"	0.210"	0.020"	0.755"	09-0/0	INOX	2.32 Lb/In	\$ 32.00
N4797	0.253"	0.185"	0.034"	1.470"	15-0/0	INOX	12.23 Lb/In	\$ 35.88
N2862	0.254"	0.214"	0.020"	0.500"	04-1/2	MW	7.18 Lb/In	\$ 16.40
N3476	0.254"	0.208"	0.020"	1.000"	08-1/2	INOX	2.40 Lb/In	\$ 31.58
N2424	0.256"	0.202"	0.027"	0.750"	09-0/0	INOX	7.90 Lb/In	\$ 32.69
N1745	0.260"	0.200"	0.030"	1.000"	09-1/2	MW	12.76 Lb/In	\$ 21.19
N8859	0.260"	0.164"	0.048"	1.500"	15-1/2	MW	59.32 Lb/In	\$ 30.37
N6677	0.260"	0.210"	0.025"	3.000"	29-0/0	INOX	1.39 Lb/In	\$ 54.59
N6144	0.262"	0.211"	0.027"	2.400"	24-0/0	MW	2.68 Lb/In	\$ 34.56
N6876	0.264"	0.203"	0.027"	1.347"	16-0/0	INOX	3.56 Lb/In	\$ 40.74
N6780	0.280"	0.230"	0.025"	0.500"	05-1/2	MW	9.68 Lb/In	\$ 17.54
N7074	0.280"	0.216"	0.032"	0.745"	10-0/0	INOX	10.74 Lb/In	\$ 31.66
N2509	0.280"	0.258"	0.011"	1.000"	16-0/0	INOX	0.07 Lb/In	\$ 33.08



# FORMAS DE ALAMBRE REDONDO



¿Dudas al medir tu forma de alambre?

Compártenos tu **diseño** ya sea por:

- Medidas.
- Fotografías.
- Plano / CAD.
- Y/O Muestra física.



**¡Te podemos fabricar una gran variedad de figuras o formas en alambre redondo!**





**¿LOS RESORTES DE TU MÁQUINA O EQUIPO REQUIEREN REEMPLAZO?**  
 Visita nuestras sucursales junto con tu muestra, nosotros te lo fabricamos.



↓ **Diámetros exteriores desde 0.280" a 0.299"** ↓

**Contamos con envío de resortes por paquetería dentro de la República Mexicana.**

MODELO	DIÁMETRO EXTERIOR (In)	DIÁMETRO INTERIOR (In)	DIÁMETRO ALAMBRE (In)	LARGO TOTAL (In)	ESPIRAS TOTALES	MATERIAL	CARGA (K)	PRECIO EN PESOS (MXN)
N6073	0.280"	0.247"	0.033"	1.000"	11-0/0	INOX	10.93 Lb/In	\$ 38.66
N6194	0.280"	0.253"	0.027"	1.280"	15-0/0	INOX	3.16 Lb/In	\$ 34.56
N1073	0.280"	0.204"	0.038"	1.750"	16-0/0	MW	15.11 Lb/In	\$ 31.93
N1351	0.280"	0.208"	0.035"	1.970"	18-3/4	INOX	7.61 Lb/In	\$ 49.44
N4865	0.281"	0.221"	0.030"	6.000"	61-0/0	INOX	1.09 Lb/In	\$ 92.37
N0087	0.284"	0.192"	0.041"	1.510"	15-0/0	MW	21.78 Lb/In	\$ 26.49
N0599	0.285"	0.253"	0.016"	1.000"	10-0/0	MW	0.60 Lb/In	\$ 19.87
N6300	0.285"	0.263"	0.011"	1.300"	20-0/0	INOX	0.05 Lb/In	\$ 36.81
N1355	0.286"	0.174"	0.056"	1.500"	16-0/0	MW	82.99 Lb/In	\$ 35.69
N2139	0.290"	0.246"	0.022"	1.100"	11-1/4	MW	1.89 Lb/In	\$ 25.71
N2875	0.290"	0.230"	0.030"	1.513"	18-0/0	INOX	3.60 Lb/In	\$ 49.30
N2766	0.290"	0.228"	0.031"	2.465"	20-1/2	MW	4.13 Lb/In	\$ 37.05
N4694	0.290"	0.210"	0.040"	3.800"	22-0/0	MW	11.78 Lb/In	\$ 38.56
N2732	0.291"	0.215"	0.038"	2.800"	24-0/0	INOX	7.32 Lb/In	\$ 57.97
N3593	0.291"	0.232"	0.027"	3.800"	20-0/0	MW	2.31 Lb/In	\$ 28.21
N7543	0.293"	0.240"	0.028"	1.170"	08-1/2	INOX	6.35 Lb/In	\$ 33.48
N8590	0.293"	0.177"	0.058"	3.000"	35-1/2	MW	37.42 Lb/In	\$ 60.04
N1440	0.294"	0.212"	0.042"	2.600"	25-1/2	INOX	10.34 Lb/In	\$ 60.66
N8503	0.295"	0.169"	0.063"	1.310"	16-0/0	MW	129.53 Lb/In	\$ 43.31
N0424	0.295"	0.261"	0.018"	1.500"	16-0/0	MW	0.51 Lb/In	\$ 29.24
N0310	0.295"	0.233"	0.031"	3.000"	22-0/0	MW	3.61 Lb/In	\$ 38.95
N8459	0.296"	0.240"	0.028"	0.870"	08-0/0	MW	7.65 Lb/In	\$ 23.06
N8461	0.296"	0.226"	0.035"	0.870"	08-0/0	MW	20.22 Lb/In	\$ 24.57
N3303	0.297"	0.265"	0.016"	0.500"	08-0/0	INOX	0.62 Lb/In	\$ 26.89
N3302	0.297"	0.265"	0.016"	0.750"	10-0/0	MW	0.53 Lb/In	\$ 20.11
N8305	0.297"	0.207"	0.045"	4.000"	35-0/0	INOX	9.71 Lb/In	\$ 75.08
N6155	0.298"	0.248"	0.025"	1.750"	14-1/2	MW	2.21 Lb/In	\$ 28.78
N3780	0.298"	0.240"	0.030"	1.765"	15-0/0	MW	4.65 Lb/In	\$ 31.90
N3102	0.298"	0.264"	0.017"	1.985"	12-1/2	MW	0.52 Lb/In	\$ 21.81
N5945	0.299"	0.253"	0.023"	0.745"	08-0/0	INOX	2.77 Lb/In	\$ 33.05
N8819	0.299"	0.219"	0.040"	1.270"	11-0/0	MW	23.53 Lb/In	\$ 27.78



# Resortes diseñados para rendir en cualquier industria y aplicación.

## Montacargas



## Motocicletas

## (OEMS) Fabricante de equipos originales



## Tráileres y equipos diésel



**¡TE ENVIAMOS TUS RESORTES VÍA PAQUETERÍA!**

Consulta con nuestro equipo la disponibilidad de envío de tus resortes.



↓ **Diámetros exteriores desde 0.300" a 0.355"** ↓

**Precios exclusivos para ventas de CATALOGO y compras ONLINE.**

MODELO	DIÁMETRO EXTERIOR (In)	DIÁMETRO INTERIOR (In)	DIÁMETRO ALAMBRE (In)	LARGO TOTAL (In)	ESPIRAS TOTALES	MATERIAL	CARGA (K)	PRECIO EN PESOS (MXN)
N6997	0.300"	0.230"	0.035"	0.500"	06-0/0	INOX	25.20 Lb/In	\$ 11.60
N5084	0.300"	0.220"	0.040"	0.500"	04-1/2	INOX	72.83 Lb/In	\$ 30.04
N3046	0.300"	0.244"	0.028"	0.750"	09-0/0	INOX	5.45 Lb/In	\$ 34.34
N9238	0.300"	0.230"	0.035"	0.750"	08-1/2	INOX	15.51 Lb/In	\$ 36.02
N5753	0.300"	0.220"	0.040"	0.750"	06-3/4	INOX	38.33 Lb/In	\$ 33.41
N2802	0.300"	0.216"	0.042"	0.867"	09-0/0	INOX	32.36 Lb/In	\$ 36.76
N4921	0.300"	0.224"	0.038"	1.000"	08-1/4	INOX	23.19 Lb/In	\$ 35.62
N6335	0.300"	0.210"	0.045"	1.000"	08-1/4	INOX	49.46 Lb/In	\$ 35.62
N1818	0.300"	0.256"	0.022"	1.500"	09-0/0	INOX	1.95 Lb/In	\$ 29.22
N9501	0.300"	0.230"	0.035"	1.500"	15-1/4	INOX	7.61 Lb/In	\$ 46.11
N3206	0.300"	0.256"	0.022"	1.745"	10-1/2	INOX	1.60 Lb/In	\$ 36.23
N1047	0.300"	0.264"	0.018"	1.800"	11-1/2	MW	0.71 Lb/In	\$ 21.88
N5833	0.300"	0.256"	0.022"	2.000"	18-1/2	INOX	0.83 Lb/In	\$ 46.30
N6631	0.300"	0.210"	0.045"	2.000"	15-1/4	MW	26.83 Lb/In	\$ 32.26
N7279	0.300"	0.208"	0.048"	2.184"	22-1/2	MW	23.26 Lb/In	\$ 39.85
N2369	0.300"	0.250"	0.025"	3.000"	24-0/0	INOX	1.07 Lb/In	\$ 53.16
N5885	0.300"	0.210"	0.045"	3.000"	32-1/2	MW	11.66 Lb/In	\$ 42.75
N2636	0.350"	0.250"	0.050"	0.500"	05-0/0	INOX	96.45 Lb/In	\$ 34.73
N0548	0.350"	0.280"	0.037"	0.870"	08-0/0	MW	14.64 Lb/In	\$ 22.55
N5588	0.350"	0.240"	0.055"	1.000"	11-0/0	MW	56.93 Lb/In	\$ 33.08
N4700	0.350"	0.230"	0.060"	1.000"	08-1/2	INOX	102.19 Lb/In	\$ 42.03
N0584	0.350"	0.280"	0.032"	1.500"	12-0/0	INOX	4.08 Lb/In	\$ 44.87
N4531	0.350"	0.266"	0.042"	1.750"	14-0/0	MW	12.76 Lb/In	\$ 33.84
N5000	0.350"	0.278"	0.026"	3.250"	23-1/4	MW	0.91 Lb/In	\$ 43.50
N8327	0.350"	0.254"	0.048"	3.950"	33-0/0	MW	8.94 Lb/In	\$ 48.48
N5433	0.353"	0.289"	0.032"	0.872"	06-1/2	MW	10.13 Lb/In	\$ 24.78
N0439	0.353"	0.296"	0.023"	1.000"	09-0/0	INOX	1.39 Lb/In	\$ 36.98
N7563	0.354"	0.284"	0.035"	1.000"	08-0/0	MW	11.08 Lb/In	\$ 26.63
N7562	0.354"	0.274"	0.040"	1.000"	08-0/0	MW	19.81 Lb/In	\$ 26.63
N1220	0.355"	0.275"	0.040"	0.500"	05-0/0	MW	39.25 Lb/In	\$ 22.96
N5418	0.355"	0.281"	0.037"	0.750"	07-3/4	INOX	12.67 Lb/In	\$ 37.63



# RESORTES DE TORSIÓN

¡Cotiza la **fabricación** de tus resortes con nuestro equipo, estamos **dispuestos a ayudarte!**



 [¡Contáctanos!](#)

**Solicita tu cotización  
y recibe atención  
personalizada.**



**¿REQUIERES UN MATERIAL O ACABADO EN ESPECÍFICO?**

Pregunta por nuestra variedad de alambres y acabados que tenemos para ofrecerte.



↓ **Diámetros exteriores desde 0.356" a 0.363"** ↓

**Consulte tolerancias e información adicional al solicitar una ficha técnica.**

MODELO	DIÁMETRO EXTERIOR (In)	DIÁMETRO INTERIOR (In)	DIÁMETRO ALAMBRE (In)	LARGO TOTAL (In)	ESPIRAS TOTALES	MATERIAL	CARGA (K)	PRECIO EN PESOS (MXN)
N0229	0.356"	0.276"	0.040"	0.750"	07-1/2	MW	21.20 Lb/In	\$ 26.07
N3971	0.356"	0.258"	0.049"	1.500"	18-0/0	MW	17.90 Lb/In	\$ 39.09
N2845	0.356"	0.276"	0.040"	2.500"	20-0/0	INOX	5.63 Lb/In	\$ 59.39
N5456	0.356"	0.266"	0.045"	2.770"	21-1/2	MW	10.05 Lb/In	\$ 43.47
N2273	0.356"	0.256"	0.050"	3.500"	30-0/0	MW	11.20 Lb/In	\$ 61.65
N3233	0.357"	0.281"	0.038"	2.450"	18-1/4	INOX	4.94 Lb/In	\$ 30.10
N5679	0.358"	0.278"	0.040"	1.280"	11-0/0	MW	12.72 Lb/In	\$ 30.51
N7172	0.358"	0.302"	0.028"	1.772"	11-1/2	INOX	2.25 Lb/In	\$ 35.08
N3042	0.359"	0.269"	0.045"	2.000"	18-3/4	MW	11.37 Lb/In	\$ 40.24
N3604	0.359"	0.269"	0.049"	2.500"	19-0/0	MW	16.36 Lb/In	\$ 40.53
N6291	0.360"	0.320"	0.020"	0.500"	06-0/0	INOX	1.27 Lb/In	\$ 32.22
N5922	0.360"	0.296"	0.032"	0.500"	05-0/0	INOX	12.38 Lb/In	\$ 32.90
N9466	0.360"	0.270"	0.045"	0.500"	05-0/0	INOX	54.66 Lb/In	\$ 32.90
N2535	0.360"	0.324"	0.018"	0.750"	08-0/0	INOX	0.55 Lb/In	\$ 35.09
N6358	0.360"	0.260"	0.045"	0.750"	06-0/0	MW	47.15 Lb/In	\$ 20.66
N4534	0.360"	0.316"	0.022"	1.250"	12-1/2	INOX	0.72 Lb/In	\$ 42.54
N3652	0.360"	0.314"	0.028"	1.250"	10-0/0	MW	3.02 Lb/In	\$ 27.14
N0666	0.360"	0.270"	0.045"	1.500"	16-0/0	MW	13.47 Lb/In	\$ 31.33
N6892	0.360"	0.256"	0.052"	1.750"	14-0/0	MW	29.98 Lb/In	\$ 38.06
N3329	0.360"	0.326"	0.017"	2.000"	10-3/4	MW	0.34 Lb/In	\$ 22.48
N0314	0.360"	0.318"	0.025"	2.000"	13-0/0	MW	1.36 Lb/In	\$ 25.74
N2859	0.360"	0.304"	0.028"	2.000"	12-0/0	MW	2.41 Lb/In	\$ 29.24
N0434	0.360"	0.296"	0.032"	2.000"	12-3/4	INOX	3.46 Lb/In	\$ 46.79
N6879	0.360"	0.258"	0.051"	2.000"	22-0/0	MW	16.48 Lb/In	\$ 50.12
N6950	0.361"	0.239"	0.061"	2.000"	15-3/4	INOX	46.62 Lb/In	\$ 70.21
N3482	0.362"	0.262"	0.050"	1.274"	10-3/4	INOX	29.40 Lb/In	\$ 47.50
N4170	0.362"	0.286"	0.038"	1.500"	12-0/0	INOX	7.66 Lb/In	\$ 45.58
N6893	0.362"	0.258"	0.052"	2.500"	21-0/0	MW	18.57 Lb/In	\$ 48.79
N6172	0.363"	0.269"	0.047"	6.000"	44-0/0	MW	5.29 Lb/In	\$ 72.47
N4611	0.363"	0.253"	0.055"	6.000"	44-1/2	MW	10.59 Lb/In	\$ 84.56
N4609	0.363"	0.237"	0.063"	6.000"	41-0/0	MW	21.51 Lb/In	\$ 100.46

# DISPONIBLE LA FABRICACIÓN DE

## ***Pasadores de Chavetas / Clips R***



Consulta nuestras existencias de chavetas  
**con medidas estándar.**

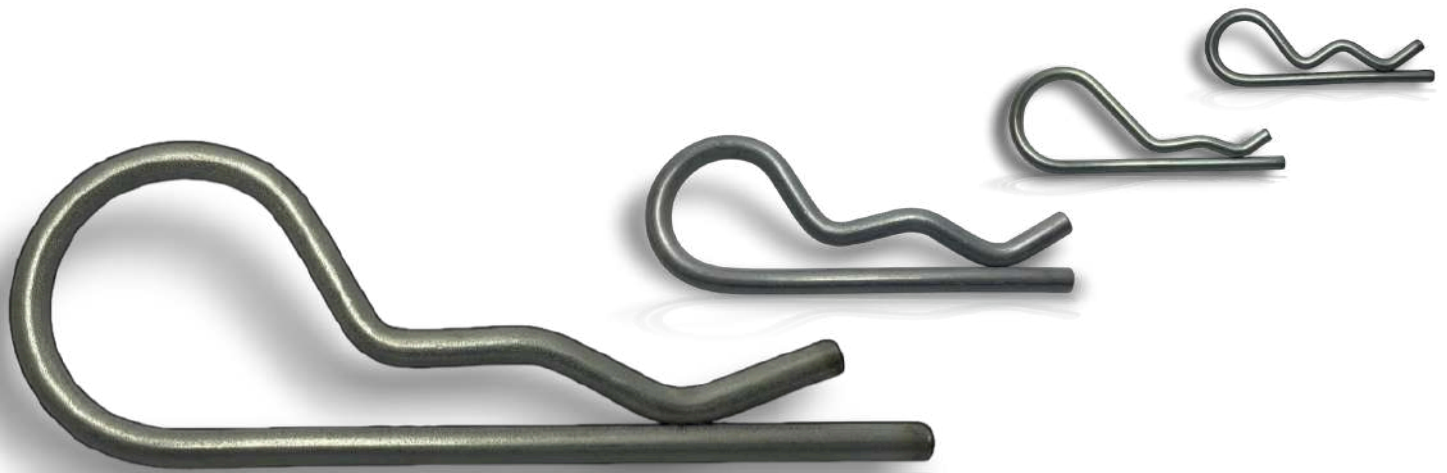

¿Necesitas una medida personalizada?  
**Te fabricamos desde una pieza en adelante.**

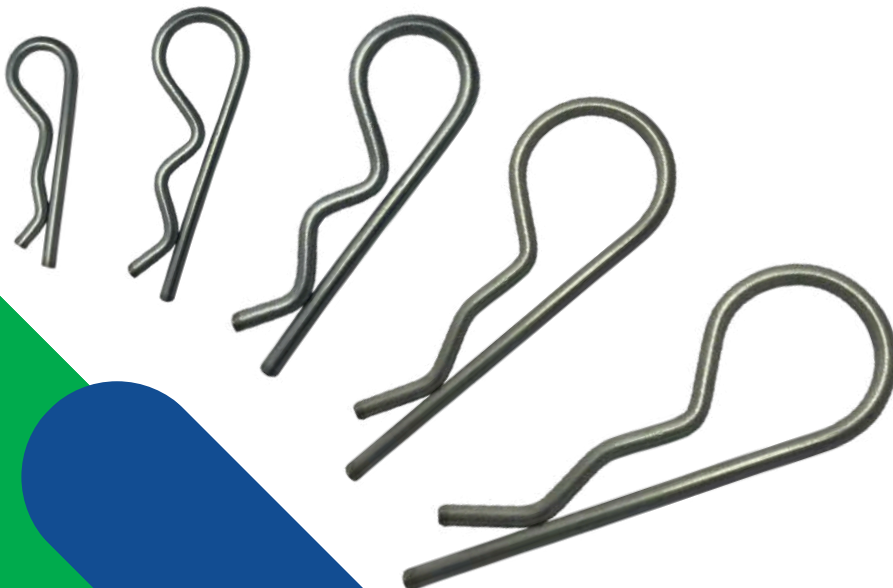

**Solicita tu cotización  
vía Whatsapp**



**899 305 8959**

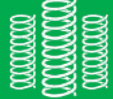

**¡PODEMOS COTIZAR TUS DIVERSOS RESORTES Y FORMAS DE ALAMBRE!**  
Fabricamos a la medida tus requerimientos en alambre redondo.



↓ **Diámetros exteriores desde 0.364" a 0.375"** ↓

**¿Problemas midiendo tu resorte? CONTÁCTANOS y te brindamos SOPORTE TÉCNICO**

MODELO	DIÁMETRO EXTERIOR (In)	DIÁMETRO INTERIOR (In)	DIÁMETRO ALAMBRE (In)	LARGO TOTAL (In)	ESPIRAS TOTALES	MATERIAL	CARGA (K)	PRECIO EN PESOS (MXN)
N3014	0.364"	0.268"	0.048"	0.510"	06-0/0	MW	60.46 Lb/In	\$ 24.38
N5825	0.364"	0.304"	0.030"	1.000"	10-0/0	INOX	3.40 Lb/In	\$ 23.75
N8824	0.364"	0.268"	0.048"	1.260"	10-0/0	MW	30.23 Lb/In	\$ 29.46
N2175	0.365"	0.275"	0.045"	2.600"	21-0/0	MW	9.47 Lb/In	\$ 43.50
N9297	0.365"	0.280"	0.043"	3.000"	21-0/0	MW	7.75 Lb/In	\$ 43.50
N0765	0.366"	0.302"	0.032"	1.000"	08-0/0	INOX	5.86 Lb/In	\$ 38.52
N3560	0.366"	0.272"	0.047"	1.783"	17-1/4	MW	14.17 Lb/In	\$ 38.78
N6545	0.368"	0.268"	0.050"	0.853"	07-3/4	INOX	42.25 Lb/In	\$ 41.32
N3643	0.370"	0.320"	0.025"	0.885"	07-0/0	INOX	2.38 Lb/In	\$ 34.51
N9042	0.370"	0.287"	0.042"	1.490"	12-0/0	INOX	11.02 Lb/In	\$ 46.04
N1344	0.370"	0.320"	0.025"	1.500"	10-1/2	INOX	1.40 Lb/In	\$ 39.95
N0188	0.371"	0.310"	0.030"	3.000"	44-1/4	MW	0.70 Lb/In	\$ 74.01
N6973	0.372"	0.312"	0.030"	0.750"	07-0/0	MW	5.82 Lb/In	\$ 25.86
N1299	0.372"	0.320"	0.026"	1.000"	07-1/2	MW	2.88 Lb/In	\$ 24.73
N0441	0.372"	0.303"	0.035"	2.000"	17-3/4	INOX	3.11 Lb/In	\$ 56.82
N0656	0.372"	0.272"	0.050"	4.500"	32-1/2	MW	8.82 Lb/In	\$ 67.56
N5423	0.372"	0.282"	0.045"	4.655"	31-1/2	MW	5.71 Lb/In	\$ 48.98
N8229	0.373"	0.330"	0.020"	1.000"	08-0/0	INOX	0.76 Lb/In	\$ 30.18
N1279	0.373"	0.333"	0.020"	1.500"	09-1/2	INOX	0.61 Lb/In	\$ 32.09
N4085	0.374"	0.298"	0.038"	2.000"	13-0/0	INOX	6.25 Lb/In	\$ 48.15
N8198	0.375"	0.355"	0.010"	0.500"	06-0/0	INOX	0.06 Lb/In	\$ 26.82
N4373	0.375"	0.305"	0.035"	0.500"	05-0/0	INOX	15.91 Lb/In	\$ 33.29
N0948	0.375"	0.195"	0.090"	0.500"	04-1/2	MW	1629.68 Lb/In	\$ 29.94
N6025	0.375"	0.250"	0.022"	0.750"	08-0/0	INOX	1.11 Lb/In	\$ 36.23
N9522	0.375"	0.305"	0.035"	0.750"	07-0/0	INOX	9.54 Lb/In	\$ 37.03
N2954	0.375"	0.345"	0.015"	1.000"	08-0/0	MW	0.26 Lb/In	\$ 20.59
N3810	0.375"	0.330"	0.022"	1.000"	10-0/0	MW	0.96 Lb/In	\$ 27.57
N7400	0.375"	0.285"	0.045"	1.030"	08-0/0	INOX	23.77 Lb/In	\$ 38.88
N0307	0.375"	0.265"	0.055"	1.250"	12-0/0	MW	40.14 Lb/In	\$ 35.80
N0352	0.375"	0.255"	0.060"	1.250"	11-0/0	INOX	57.59 Lb/In	\$ 48.91
N5859	0.375"	0.255"	0.062"	1.500"	12-1/2	MW	65.97 Lb/In	\$ 43.57



# RESORTES AL TAMAÑO DE TUS PROYECTOS

¡Somos **expertos** en la fabricación de resortes de **grandes medidas**, listos para adaptarse a cualquier necesidad industrial!

**¡Diseña tus resortes**

**NOSOTROS LOS  
HACEMOS REALIDAD!**





**¿NECESITAS INVENTARIO DE RESORTES CON VARIEDAD DE MEDIDAS?**  
**Adquiere tu KIT PARA TÉCNICO REPARADOR con resortes de medidas estándar.**



↓ **Diámetros exteriores desde 0.375" a 0.390"** ↓

**Precios exclusivos para ventas de CATÁLOGO y compras ONLINE.**

MODELO	DIÁMETRO EXTERIOR (In)	DIÁMETRO INTERIOR (In)	DIÁMETRO ALAMBRE (In)	LARGO TOTAL (In)	ESPIRAS TOTALES	MATERIAL	CARGA (K)	PRECIO EN PESOS (MXN)
N8483	0.375"	0.305"	0.035"	1.750"	16-1/2	MW	3.79 Lb/In	\$ 38.35
N5531	0.375"	0.327"	0.024"	1.785"	17-0/0	MW	0.74 Lb/In	\$ 35.26
N6103	0.375"	0.250"	0.062"	2.000"	28-0/0	MW	26.64 Lb/In	\$ 76.01
N5521	0.375"	0.305"	0.035"	2.500"	19-1/2	INOX	2.73 Lb/In	\$ 60.37
N9502	0.375"	0.251"	0.062"	3.000"	20-3/4	MW	36.94 Lb/In	\$ 60.83
N5076	0.375"	0.303"	0.040"	4.000"	31-1/2	MW	3.32 Lb/In	\$ 57.97
N2110	0.375"	0.291"	0.042"	4.000"	31-0/0	INOX	3.63 Lb/In	\$ 81.85
N8302	0.375"	0.305"	0.035"	6.000"	34-3/4	MW	1.68 Lb/In	\$ 52.87
N5074	0.375"	0.295"	0.040"	6.000"	42-1/2	MW	2.42 Lb/In	\$ 72.31
N0837	0.377"	0.301"	0.038"	1.000"	07-0/0	INOX	13.38 Lb/In	\$ 37.09
N3586	0.377"	0.315"	0.028"	1.250"	12-1/2	MW	1.98 Lb/In	\$ 25.81
N3419	0.378"	0.270"	0.053"	2.921"	20-0/0	INOX	15.96 Lb/In	\$ 69.46
N6792	0.380"	0.272"	0.054"	1.000"	07-0/0	INOX	61.36 Lb/In	\$ 40.17
N0506	0.380"	0.318"	0.032"	1.250"	08-1/4	INOX	4.98 Lb/In	\$ 39.56
N4532	0.380"	0.316"	0.032"	1.750"	19 0/0	MW	2.10 Lb/In	\$ 41.92
N5767	0.380"	0.315"	0.035"	3.000"	21-1/2	INOX	2.34 Lb/In	\$ 54.96
N8298	0.380"	0.320"	0.020"	6.000"	34-3/4	MW	0.15 Lb/In	\$ 45.36
N8297	0.380"	0.320"	0.026"	6.000"	34-3/4	MW	0.45 Lb/In	\$ 46.97
N8296	0.380"	0.320"	0.030"	6.000"	34-3/4	MW	0.83 Lb/In	\$ 53.38
N1535	0.382"	0.292"	0.045"	0.869"	08-1/2	MW	23.69 Lb/In	\$ 23.87
N0992	0.384"	0.300"	0.042"	0.785"	05-1/2	MW	31.95 Lb/In	\$ 24.14
N6108	0.385"	0.297"	0.044"	1.310"	10-0/0	MW	16.98 Lb/In	\$ 30.18
N3484	0.385"	0.281"	0.052"	2.493"	19-1/2	INOX	14.14 Lb/In	\$ 69.14
N0518	0.385"	0.275"	0.055"	4.439"	23-3/4	MW	16.83 Lb/In	\$ 55.24
N0422	0.385"	0.305"	0.040"	5.000"	34-1/2	MW	2.76 Lb/In	\$ 53.59
N4220	0.386"	0.318"	0.034"	1.245"	09-3/4	INOX	4.94 Lb/In	\$ 16.24
N1485	0.387"	0.237"	0.075"	2.000"	16-0/0	MW	106.97 Lb/In	\$ 61.04
N3375	0.390"	0.286"	0.052"	0.500"	06-0/0	INOX	59.17 Lb/In	\$ 38.23
N6451	0.390"	0.294"	0.048"	0.750"	06-0/0	MW	47.69 Lb/In	\$ 24.92
N3764	0.390"	0.260"	0.065"	0.780"	06-1/2	MW	166.11 Lb/In	\$ 31.58
N6450	0.390"	0.294"	0.048"	1.000"	09-0/0	MW	27.25 Lb/In	\$ 29.00



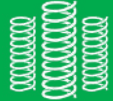

**¡TE ENVIAMOS TUS RESORTES VÍA PAQUETERÍA!**

Consulta con nuestro equipo la disponibilidad de envío de tus resortes.



↓ Diámetros exteriores desde 0.390" a 0.480" ↓

Las imágenes mostradas en este catalogo son referencias visuales.

MODELO	DIÁMETRO EXTERIOR (In)	DIÁMETRO INTERIOR (In)	DIÁMETRO ALAMBRE (In)	LARGO TOTAL (In)	ESPIRAS TOTALES	MATERIAL	CARGA (K)	PRECIO EN PESOS (MXN)
N2388	0.390"	0.230"	0.080"	1.300"	10-0/0	MW	247.05 Lb/In	\$ 45.65
N9223	0.392"	0.260"	0.067"	1.300"	09-3/4	INOX	94.68 Lb/In	\$ 55.34
N0730	0.398"	0.270"	0.064"	4.500"	25-0/0	MW	28.14 Lb/In	\$ 62.00
N6606	0.404"	0.364"	0.020"	2.100"	18-0/0	MW	0.25 Lb/In	\$ 36.81
N6297	0.410"	0.280"	0.064"	0.850"	05-0/0	INOX	168.76 Lb/In	\$ 41.25
N2061	0.410"	0.314"	0.048"	1.500"	12-0/0	MW	16.09 Lb/In	\$ 33.91
N5261	0.470"	0.412"	0.030"	0.472"	06-0/0	MW	3.42 Lb/In	\$ 22.59
N5957	0.470"	0.373"	0.048"	1.000"	07-0/0	MW	20.31 Lb/In	\$ 28.25
N6497	0.471"	0.395"	0.038"	2.000"	13-1/2	MW	3.21 Lb/In	\$ 33.08
N5355	0.472"	0.348"	0.062"	1.000"	09-0/0	MW	44.03 Lb/In	\$ 41.13
N5356	0.472"	0.348"	0.062"	1.500"	12-3/4	MW	28.67 Lb/In	\$ 50.98
N5638	0.475"	0.319"	0.078"	0.785"	06-0/0	MW	212.60 Lb/In	\$ 37.73
N2815	0.475"	0.295"	0.090"	1.000"	07-1/2	MW	300.49 Lb/In	\$ 43.26
N5115	0.475"	0.399"	0.038"	1.500"	13-0/0	MW	3.27 Lb/In	\$ 38.27
N1093	0.475"	0.367"	0.054"	3.000"	17-0/0	MW	10.92 Lb/In	\$ 50.77
N6254	0.475"	0.331"	0.072"	5.000"	29-0/0	MW	21.86 Lb/In	\$ 113.92
N8285	0.476"	0.392"	0.042"	4.000"	26-0/0	INOX	1.98 Lb/In	\$ 85.61
N5372	0.477"	0.417"	0.026"	1.000"	08-0/0	INOX	1.04 Lb/In	\$ 33.70
N1859	0.478"	0.392"	0.043"	0.985"	06-0/0	INOX	12.98 Lb/In	\$ 38.23
N1186	0.478"	0.398"	0.040"	1.000"	08-0/0	MW	7.30 Lb/In	\$ 30.10
N1640	0.478"	0.422"	0.028"	1.970"	14-0/0	INOX	0.70 Lb/In	\$ 43.93
N1027	0.479"	0.363"	0.058"	1.000"	07-1/2	MW	39.64 Lb/In	\$ 32.00
N6220	0.480"	0.408"	0.036"	0.500"	04-1/2	INOX	9.59 Lb/In	\$ 34.70
N7525	0.480"	0.390"	0.045"	0.500"	04-1/4	INOX	27.68 Lb/In	\$ 34.13
N7331	0.480"	0.420"	0.030"	0.750"	07-1/4	MW	2.43 Lb/In	\$ 28.90
N4403	0.480"	0.390"	0.045"	0.750"	05-1/2	INOX	17.79 Lb/In	\$ 37.09
N7611	0.480"	0.370"	0.054"	1.000"	07-3/4	INOX	23.91 Lb/In	\$ 46.50
N7310	0.480"	0.396"	0.042"	2.000"	14-0/0	MW	4.44 Lb/In	\$ 40.21
N6371	0.480"	0.370"	0.055"	2.000"	13-0/0	MW	15.58 Lb/In	\$ 43.11
N2411	0.480"	0.404"	0.038"	2.500"	13-0/0	MW	3.16 Lb/In	\$ 32.72

# PRECIOS ESPECIALES POR MAYOREO



**¡Grandes Pedidos, Grandes Descuentos!**  
Solicita ya tu cotización y empieza a disfrutar  
de nuestros precios exclusivos.



Contamos con capacidad para fabricar  
**grandes cantidades de piezas** que  
requieras para **cualquier tipo de proyecto.**

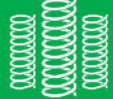

## ¿BUSCAS RESORTES CON FORMA CÓNICA O BICÓNICA?

Consulta a nuestros ingenieros y solicita tu fabricación a la medida.



↓ Diámetros exteriores desde 0.480" a 0.500" ↓

Consulta los descuentos en compras POR GRANDES CANTIDADES.

MODELO	DIÁMETRO EXTERIOR (In)	DIÁMETRO INTERIOR (In)	DIÁMETRO ALAMBRE (In)	LARGO TOTAL (In)	ESPIRAS TOTALES	MATERIAL	CARGA (K)	PRECIO EN PESOS (MXN)
N6386	0.480"	0.390"	0.045"	2.500"	14-0/0	MW	5.97 Lb/In	\$ 40.21
N6651	0.480"	0.390"	0.045"	6.000"	36-1/2	INOX	1.80 Lb/In	\$ 111.20
N3851	0.482"	0.410"	0.033"	2.000"	13-0/0	INOX	1.49 Lb/In	\$ 55.13
N4934	0.482"	0.404"	0.039"	3.000"	15-3/4	INOX	2.42 Lb/In	\$ 61.76
N3256	0.483"	0.357"	0.063"	2.000"	13-0/0	MW	27.79 Lb/In	\$ 52.44
N5172	0.485"	0.345"	0.070"	3.500"	24-0/0	MW	21.95 Lb/In	\$ 99.03
N3660	0.487"	0.430"	0.034"	1.000"	06-0/0	MW	5.17 Lb/In	\$ 26.96
N2983	0.490"	0.437"	0.028"	0.470"	04-0/0	INOX	3.90 Lb/In	\$ 27.10
N2344	0.490"	0.388"	0.051"	0.500"	04-0/0	MW	57.47 Lb/In	\$ 25.16
N4208	0.490"	0.380"	0.055"	0.500"	04-0/0	INOX	69.48 Lb/In	\$ 35.98
N7217	0.492"	0.348"	0.072"	0.465"	05-0/0	INOX	151.14 Lb/In	\$ 50.05
N3289	0.492"	0.363"	0.059"	0.750"	05-0/0	INOX	62.19 Lb/In	\$ 38.95
N2752	0.494"	0.414"	0.040"	4.000"	25-3/4	MW	1.66 Lb/In	\$ 61.12
N2965	0.498"	0.406"	0.046"	2.000"	16-0/0	MW	4.98 Lb/In	\$ 37.84
N2033	0.498"	0.374"	0.063"	6.000"	26-1/2	MW	11.23 Lb/In	\$ 91.05
N8900	0.500"	0.376"	0.062"	0.500"	04-0/0	MW	126.39 Lb/In	\$ 28.57
N4408	0.500"	0.448"	0.026"	0.750"	08-1/2	INOX	0.83 Lb/In	\$ 41.46
N5558	0.500"	0.430"	0.035"	0.750"	07-0/0	INOX	3.73 Lb/In	\$ 41.39
N4268	0.500"	0.402"	0.049"	0.750"	05-3/4	INOX	20.95 Lb/In	\$ 38.27
N4618	0.500"	0.378"	0.062"	0.750"	05-0/0	INOX	73.27 Lb/In	\$ 44.82
N4940	0.500"	0.375"	0.062"	1.000"	06-1/2	MW	56.17 Lb/In	\$ 35.55
N2994	0.500"	0.392"	0.054"	1.500"	11-1/2	MW	14.50 Lb/In	\$ 41.03
N3912	0.500"	0.450"	0.050"	2.500"	17-1/2	MW	6.36 Lb/In	\$ 45.54
N5431	0.500"	0.392"	0.054"	2.500"	17-0/0	MW	9.19 Lb/In	\$ 44.68
N6595	0.500"	0.332"	0.084"	2.500"	20-1/2	MW	53.74 Lb/In	\$ 90.84
N3844	0.500"	0.420"	0.040"	3.000"	23-0/0	MW	1.80 Lb/In	\$ 56.85
N1660	0.500"	0.404"	0.048"	3.500"	23-3/4	INOX	3.30 Lb/In	\$ 83.10
N9465	0.500"	0.392"	0.054"	4.000"	27-0/0	INOX	4.79 Lb/In	\$ 104.93
N3594	0.500"	0.432"	0.035"	5.000"	26-0/0	MW	0.89 Lb/In	\$ 62.08
N1717	0.500"	0.424"	0.038"	6.000"	19-1/2	INOX	1.51 Lb/In	\$ 61.62



# ¿NO ENCONTRASTE TU RESORTE?



➤ **Contamos con más de**

**10,000  
MODELOS**

**disponibles para  
ofrecerte.**

***Resortes de calidad a  
tu alcance.***

**¡SOLO EN  
RESORTES  
NAVE!**





## Tipos de materiales en los modelos listados:

Alambre Piano (MW)



Acero Inoxidable (INOX)



## Referencias

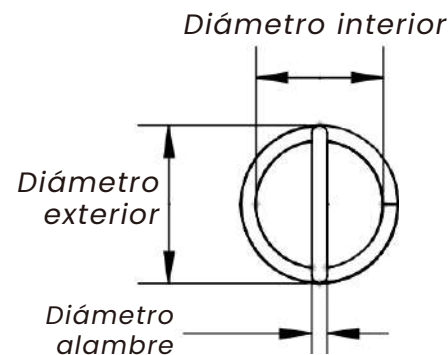
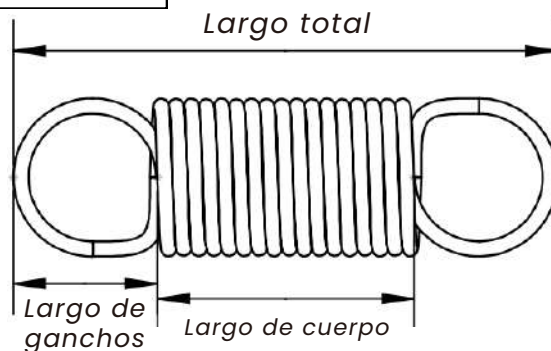

**Materiales:** (MW - Alambre Piano) / (INOX 302/304- Alambre Inoxidable)  
**Acabado:** Natural

↓ Diámetros exteriores desde 0.120" a 0.189" ↓

¿Problemas midiendo tu resorte? **CONTÁCTANOS** y te brindamos **SOPORTE TÉCNICO**

MODELO	DIÁMETRO EXTERIOR (In)	DIÁMETRO ALAMBRE (In)	LARGO DE CUERPO (In)	LARGO TOTAL (IN)	LARGO DE GANCHOS (IN)	MATERIAL	CARGA (K)	PRECIO EN PESOS (MXN)
N5388	0.120"	0.020"	0.740"	0.980"	0.120"	MW	6.22 Lb/In	\$ 12.10
N8620	0.120"	0.018"	1.260"	1.500"	0.120"	INOX	1.77 Lb/In	\$ 26.71
N6490	0.125"	0.014"	0.750"	1.000"	0.125"	INOX	0.66 Lb/In	\$ 18.69
N7001	0.125"	0.015"	1.250"	1.500"	0.125"	MW	0.66 Lb/In	\$ 14.79
N2438	0.125"	0.020"	1.500"	1.750"	0.110"	MW	2.65 Lb/In	\$ 17.88
N0538	0.129"	0.009"	0.695"	0.929"	0.117"	MW	0.07 Lb/In	\$ 13.23
N1976	0.131"	0.025"	0.130"	0.330"	0.100"	INOX	78.84 Lb/In	\$ 12.99
N3567	0.135"	0.016"	0.211"	0.555"	0.172"	INOX	78.84 Lb/In	\$ 16.25
N0428	0.150"	0.025"	0.370"	0.781"	0.190"	MW	19.43 Lb/In	\$ 9.60
N7000	0.156"	0.015"	1.188"	1.500"	0.156"	MW	0.33 Lb/In	\$ 18.37
N0742	0.172"	0.024"	0.280"	0.575"	0.150"	MW	12.61 Lb/In	\$ 8.97
N1446	0.172"	0.027"	0.333"	0.625"	0.140"	INOX	17.67 Lb/In	\$ 15.82
N6264	0.185"	0.014"	1.012"	1.350"	0.170"	MW	0.15 Lb/In	\$ 19.73
N0160	0.186"	0.024"	0.945"	1.260"	0.155"	MW	2.85 Lb/In	\$ 18.46
N3144	0.187"	0.026"	0.335"	0.680"	0.146"	MW	12.22 Lb/In	\$ 11.25
N3005	0.187"	0.032"	0.500"	0.861"	0.165"	MW	25.91 Lb/In	\$ 11.88
N7186	0.188"	0.016"	0.313"	0.657"	0.172"	MW	0.95 Lb/In	\$ 10.14
N7185	0.188"	0.018"	0.321"	0.661"	0.170"	MW	1.72 Lb/In	\$ 12.93
N7184	0.188"	0.020"	0.329"	0.665"	0.168"	MW	2.95 Lb/In	\$ 12.16
N7187	0.188"	0.026"	0.353"	0.677"	0.162"	MW	11.38 Lb/In	\$ 11.73
N7190	0.188"	0.031"	0.373"	0.687"	0.157"	MW	28.51 Lb/In	\$ 11.79
N6278	0.189"	0.023"	0.845"	1.260"	0.207"	INOX	2.08 Lb/In	\$ 27.11



**¿NECESITAS INVENTARIO DE RESORTES CON VARIEDAD DE MEDIDAS?**  
Adquiere tu KIT PARA TÉCNICO REPARADOR con resortes de medidas estándar.



↓ **Diámetros exteriores desde 0.195" a 0.250"** ↓

**Precios exclusivos para ventas de CÁTALOGO y compras ONLINE.**

MODELO	DIÁMETRO EXTERIOR (In)	DIÁMETRO ALAMBRE (In)	LARGO DE CUERPO (In)	LARGO TOTAL (IN)	LARGO DE GANCHOS (IN)	MATERIAL	CARGA (K)	PRECIO EN PESOS (MXN)
N0222	0.195"	0.027"	0.665"	1.000"	0.167"	MW	6.54 Lb/In	\$ 16.04
N5404	0.197"	0.023"	0.200"	0.550"	0.197"	MW	8.78 Lb/In	\$ 13.50
N0100	0.197"	0.025"	0.437"	0.826"	0.194"	MW	6.31 Lb/In	\$ 13.19
N3040	0.197"	0.023"	0.530"	0.888"	0.175"	INOX	2.88 Lb/In	\$ 21.05
N2449	0.202"	0.018"	1.000"	1.400"	0.200"	MW	0.44 Lb/In	\$ 24.05
N2240	0.204"	0.030"	0.816"	1.080"	0.132"	MW	8.13 Lb/In	\$ 16.31
N1038	0.206"	0.012"	1.000"	1.360"	0.182"	MW	0.05 Lb/In	\$ 24.80
N1039	0.206"	0.012"	1.600"	2.000"	0.200"	MW	0.03 Lb/In	\$ 33.76
N3404	0.218"	0.027"	0.918"	1.276"	0.185"	MW	3.22 Lb/In	\$ 20.97
N1699	0.229"	0.020"	0.345"	0.730"	0.180"	MW	1.46 Lb/In	\$ 14.69
N0638	0.234"	0.038"	0.441"	0.773"	0.166"	MW	34.30 Lb/In	\$ 16.73
N2860	0.235"	0.021"	0.321"	0.756"	0.210"	MW	1.87 Lb/In	\$ 13.63
N4634	0.240"	0.032"	0.575"	1.055"	0.240"	INOX	8.11 Lb/In	\$ 24.95
N6063	0.242"	0.030"	0.326"	0.750"	0.212"	MW	11.25 Lb/In	\$ 11.98
N0755	0.242"	0.016"	1.000"	1.450"	0.210"	MW	0.13 Lb/In	\$ 22.07
N0541	0.243"	0.021"	0.814"	1.285"	0.236"	INOX	0.57 Lb/In	\$ 35.51
N5439	0.245"	0.031"	0.569"	1.050"	0.240"	MW	7.38 Lb/In	\$ 16.80
N6279	0.245"	0.031"	0.740"	1.180"	0.220"	MW	5.67 Lb/In	\$ 18.91
N0495	0.245"	0.019"	0.844"	1.269"	0.212"	INOX	0.32 Lb/In	\$ 40.48
N1843	0.250"	0.039"	0.320"	0.750"	0.220"	MW	43.15 Lb/In	\$ 13.54
N1034	0.250"	0.028"	0.335"	0.800"	0.232"	MW	6.75 Lb/In	\$ 13.19
N3427	0.250"	0.025"	0.570"	1.000"	0.230"	MW	2.16 Lb/In	\$ 16.53
N5148	0.250"	0.028"	0.500"	1.000"	0.250"	INOX	3.93 Lb/In	\$ 23.22
N5907	0.250"	0.022"	0.785"	1.285"	0.250"	MW	0.80 Lb/In	\$ 21.98
N1036	0.250"	0.027"	1.000"	1.500"	0.250"	MW	1.86 Lb/In	\$ 22.76
N0493	0.250"	0.028"	1.335"	1.746"	0.205"	MW	1.69 Lb/In	\$ 26.90
N4068	0.250"	0.027"	1.335"	1.835"	0.250"	MW	1.39 Lb/In	\$ 27.82
N3990	0.250"	0.020"	1.500"	2.000"	0.250"	INOX	0.22 Lb/In	\$ 52.25
N0750	0.250"	0.030"	2.000"	2.400"	0.200"	INOX	1.43 Lb/In	\$ 49.09
N3741	0.250"	0.021"	2.020"	2.430"	0.200"	MW	0.24 Lb/In	\$ 39.99
N6634	0.250"	0.035"	2.650"	3.087"	0.238"	MW	2.87 Lb/In	\$ 35.24

Para más información sobre algún modelo, solicite la ficha técnica con su asistente de ventas.



## ¿NECESITAS RESORTES CON DIFERENTES TIPOS DE GANCHOS?

Consulta a nuestros agentes de ventas y conoce la variedad de ganchos que manejamos.



↓ Diámetros exteriores desde 0.270" a 0.460" ↓

Contáctanos para ordenar tus resortes POR CANTIDADES GRANDES.

MODELO	DIÁMETRO EXTERIOR (In)	DIÁMETRO ALAMBRE (In)	LARGO DE CUERPO (In)	LARGO TOTAL (IN)	LARGO DE GANCHOS (IN)	MATERIAL	CARGA (K)	PRECIO EN PESOS (MXN)
N6207	0.270"	0.035"	2.540"	3.000"	0.230"	MW	2.29 Lb/In	\$ 36.42
N2546	0.280"	0.040"	5.440"	6.000"	0.280"	INOX	1.70 Lb/In	\$ 110.27
N1418	0.306"	0.035"	0.247"	0.847"	0.300"	INOX	13.36 Lb/In	\$ 32.51
N1795	0.310"	0.026"	0.550"	1.080"	0.265"	MW	1.36 Lb/In	\$ 21.99
N0828	0.310"	0.024"	0.700"	1.275"	0.270"	MW	0.70 Lb/In	\$ 23.20
N3970	0.310"	0.035"	2.000"	2.591"	0.330"	INOX	1.58 Lb/In	\$ 59.10
N5307	0.310"	0.043"	2.000"	2.600"	0.300"	INOX	4.83 Lb/In	\$ 75.10
N8384	0.310"	0.029"	2.380"	3.000"	0.310"	INOX	0.49 Lb/In	\$ 71.16
N0159	0.310"	0.044"	2.500"	3.080"	0.250"	MW	5.04 Lb/In	\$ 51.74
N6678	0.313"	0.030"	2.874"	3.500"	0.313"	MW	0.54 Lb/In	\$ 47.12
N3406	0.318"	0.054"	1.900"	2.494"	0.279"	MW	18.88 Lb/In	\$ 42.04
N2931	0.337"	0.032"	2.000"	2.750"	0.375"	MW	0.85 Lb/In	\$ 45.21
N9451	0.344"	0.050"	1.904"	2.544"	0.320"	INOX	8.07 Lb/In	\$ 71.79
N0552	0.359"	0.045"	4.475"	5.090"	0.307"	INOX	1.66 Lb/In	\$ 129.75
N1018	0.360"	0.054"	3.435"	4.125"	0.345"	INOX	5.83 Lb/In	\$ 93.73
N1810	0.360"	0.048"	3.450"	4.130"	0.315"	INOX	3.04 Lb/In	\$ 100.97
N2959	0.373"	0.046"	4.000"	4.750"	0.375"	INOX	1.84 Lb/In	\$ 118.17
N3592	0.375"	0.054"	3.500"	4.250"	0.375"	INOX	4.96 Lb/In	\$ 95.30
N2838	0.378"	0.042"	3.000"	3.700"	0.350"	MW	1.65 Lb/In	\$ 56.21
N4176	0.378"	0.034"	5.322"	5.973"	0.355"	MW	0.30 Lb/In	\$ 86.68
N0336	0.388"	0.050"	3.800"	4.460"	0.325"	MW	3.06 Lb/In	\$ 71.51
N3690	0.389"	0.050"	2.300"	3.000"	0.350"	MW	5.01 Lb/In	\$ 57.12
N0149	0.390"	0.049"	1.600"	2.300"	0.350"	INOX	5.57 Lb/In	\$ 71.98
N4215	0.394"	0.048"	0.965"	1.785"	0.410"	MW	9.16 Lb/In	\$ 38.91
N1398	0.398"	0.066"	0.474"	1.842"	0.878"	INOX	90.25 Lb/In	\$ 35.30
N6273	0.400"	0.043"	0.575"	1.275"	0.350"	INOX	7.02 Lb/In	\$ 47.12
N2767	0.406"	0.041"	0.380"	1.135"	0.364"	MW	9.01 Lb/In	\$ 23.05
N4018	0.426"	0.060"	4.450"	5.230"	0.390"	MW	5.12 Lb/In	\$ 78.22
N6822	0.438"	0.031"	3.124"	4.000"	0.438"	MW	0.20 Lb/In	\$ 70.77
N1390	0.444"	0.054"	2.240"	3.000"	0.360"	MW	4.97 Lb/In	\$ 64.28
N8299	0.460"	0.063"	4.382"	5.182"	0.400"	MW	5.20 Lb/In	\$ 79.18

**¿LOS RESORTES DE TU CORTINA METÁLICA O PORTÓN SE DAÑARON?**  
Te fabricamos tus resortes completamente a la medida según tu necesidad.



↓ **Diámetros exteriores desde 0.476" a 0.506"** ↓

**Las imágenes mostradas en este catalogo son referencias visuales.**

MODELO	DIÁMETRO EXTERIOR (In)	DIÁMETRO ALAMBRE (In)	LARGO DE CUERPO (In)	LARGO TOTAL (IN)	LARGO DE GANCHOS (IN)	MATERIAL	CARGA (K)	PRECIO EN PESOS (MXN)
N4888	0.476"	0.048"	5.060"	6.000"	0.470"	INOX	0.80 Lb/In	\$ 177.22
N8068	0.485"	0.080"	0.320"	1.120"	0.400"	MW	221.59 Lb/In	\$ 17.30
N4460	0.494"	0.047"	0.511"	1.348"	0.418"	MW	7.22 Lb/In	\$ 30.73
N3651	0.495"	0.063"	4.600"	5.590"	0.495"	MW	3.85 Lb/In	\$ 29.32
N3505	0.498"	0.048"	1.140"	2.010"	0.430"	INOX	3.07 Lb/In	\$ 76.78
N2634	0.500"	0.061"	0.500"	1.200"	0.350"	INOX	24.96 Lb/In	\$ 39.20
N1074	0.500"	0.064"	1.000"	2.020"	0.510"	MW	18.62 Lb/In	\$ 35.61
N3371	0.500"	0.040"	1.500"	2.367"	0.500"	INOX	0.88 Lb/In	\$ 85.43
N9368	0.500"	0.058"	2.200"	3.036"	0.418"	INOX	4.32 Lb/In	\$ 101.69
N6431	0.500"	0.050"	3.500"	4.425"	0.462"	INOX	1.22 Lb/In	\$ 129.98
N3129	0.500"	0.060"	5.040"	6.040"	0.500"	MW	2.60 Lb/In	\$ 101.09
N4217	0.500"	0.042"	5.500"	6.500"	0.500"	MW	0.36 Lb/In	\$ 122.72
N1306	0.502"	0.053"	2.195"	3.165"	0.485"	MW	3.03 Lb/In	\$ 72.17
N0005	0.506"	0.077"	0.460"	1.190"	0.325"	MW	107.14 Lb/In	\$ 23.95

**¡Podemos ofrecerte una amplia variedad de tipos de ganchos en tus resortes!**

-  ➤ Gancho (simple)
-  ➤ Gancho abierto
-  ➤ Gancho bastón
-  ➤ Sin gancho

**Y muchos más!**



Solicita tu cotización de fabricación de modelos personalizados.



# VISITA NUESTRAS SUCURSALES



## **Sucursal Jarachina Sur**

 Avenida Las Lomas #1045,  
Lomas del Real de Jarachina  
Sur, C.P. 88730 Reynosa,  
Tamaulipas

 **Atención Mostrador**  
ventas1@resortesnave.com

 **Atención a Maquiladoras**  
ventas@resortesnave.com

 (899) 929 61 81  
(899) 688 4329

## **Sucursal Fracc. Reynosa**

 Calle Elías 527-A. Fracc.  
Reynosa Entre Delia y Rosita  
C.P. 88780 Reynosa,  
Tamaulipas.

 **Atención Mostrador**  
ventas2@resortesnave.com

 **Atención a Maquiladoras**  
ventasrey@resortesnave.com

 (899) 926 75 20  
(899) 926 90 52

## **Suc. H. Matamoros**

 Calle Natividad Lara #12 Local  
7 Colonia 20 de Noviembre,  
Heróica Matamoros,  
Tamaulipas C.P. 87399

 **Atención Mostrador**  
ventas3@resortesnave.com

 **Atención a Maquiladoras**  
ventasmat@resortesnave.com

 (868) 374 98 97  
(868) 375 89 10

**Atención de Lunes a Viernes  
08:00 - 18:00**



**899 305 8959**

 **Resortes Nave**

 **www.ResortesNave.com**

 **contacto@ResortesNave.com**

**Catálogo de Resortes 2025 | Resortes Nave**